

AC310 High Performance Vector Frequency Inverter



AC310 series high-performance inverter

VEICHI Electric, a high-tech enterprise engaged in the R&D, production and sales of industrial automation products, has always focused on the fields of electric drive and industrial control since its establishment. It has been listed as the "Jiangsu Provincial Enterprise Technology Center", "Jiangsu Private Technology Enterprise", "Jiangsu Provincial Specialized and New Giant Enterprise", "Jiangsu Provincial Engineering Technology Research Center", "Suzhou Gazelle Enterprise" and "Competitive Brand in Motion Control Field". After years of independent R&D and innovation, VEICHI has developed a series of independent intellectual property rights. By the end of December 28, 2021, a total of 124 patents have been granted, including 28 invention patents.

VEICHI has R&D and production bases in Suzhou and Shenzhen, and has established a wholly-owned subsidiary in India. At present, the company's business covers many countries and regions, providing global customers with competitive, safe and reliable products and services.

We supply a wide range of products, including inverters from 0.4kW to 5,600kW, servo systems from 50W to 200kW, motion controllers, PLCs and HMIs, to diverse customers in lifting and mining equipment, rail transportation, machine tools, compressors, plastics, solar water pumping, building materials, robots or manipulators, printing and packaging, textile and chemical fiber, metallurgy, municipal, petroleum, chemical and other industries.

VEICHI has established 19 service outlets in China, and developed 139 channel dealers, covering 31 provinces and Hong Kong, Macao and Taiwan regions across the country, forming a wide-ranging and efficient distribution and service network to provide customers with high-quality products and efficient Service.

VEICHI will continue to adhere to the business philosophy of "Guided by market demand, Driven by technological innovation", to expand and strengthen the core businesses of inverters, servo systems and motion controllers, and intelligent IoT, and always insist on providing customers with best products and services. VEICHI will spare no effort to make contributions to promote the development of electric drive and industrial control.

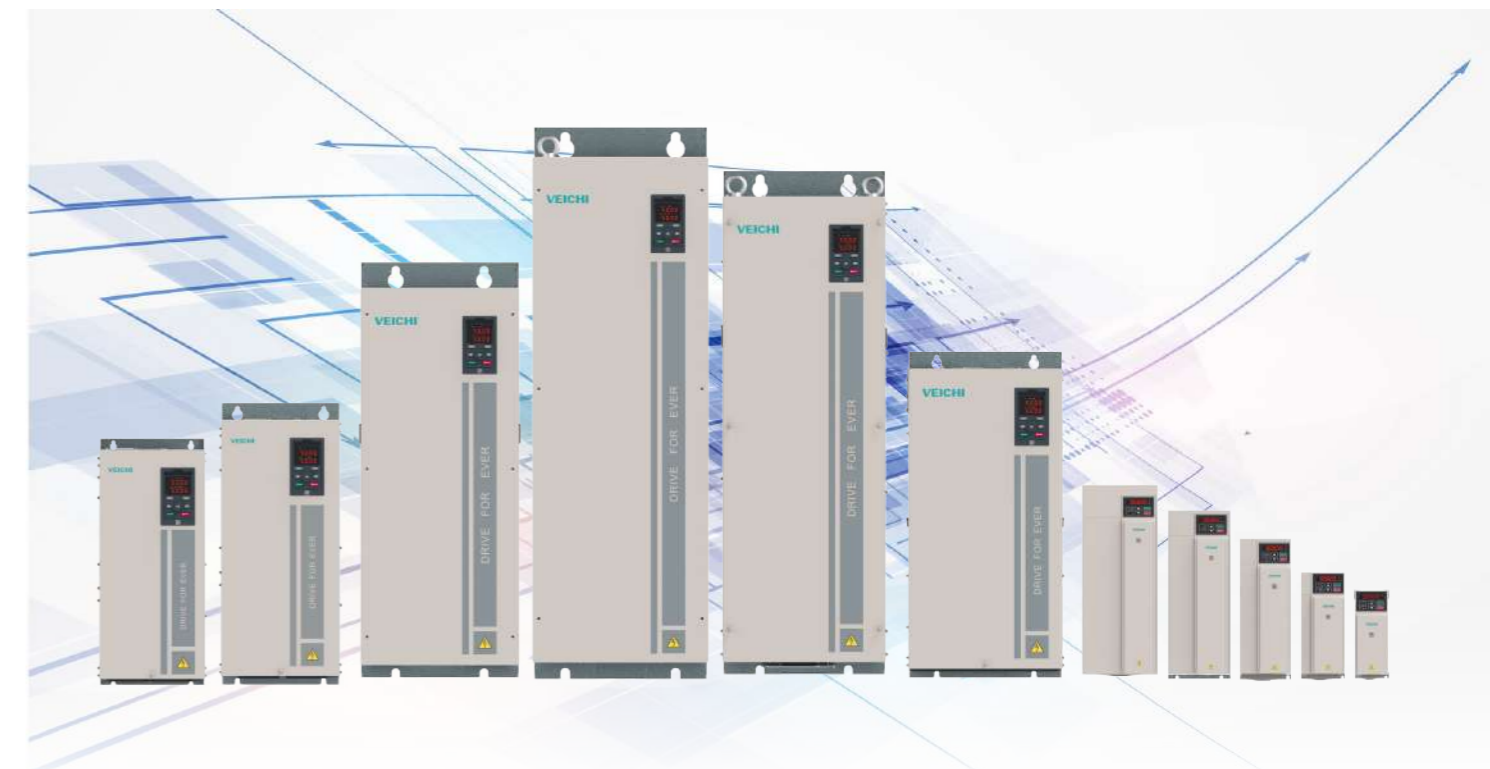

Simple in type
good at heart

Inherit the good platform technology of VEICHI;
Leading vector technology of the industry;
Synchronous / asynchronous drive;
Integrate multi-industry applications;



Make it simple

Simple wiring, European-style terminals, saving wiring time, cut costs;
Adopt general parameter arrangement, optimize the panel buttons, simple to use;
Simple debugging, dedicated PC software, minimize debugging;
Reduce the debugging time and difficulty ;



Thinner, design and
aesthetics integrated

Book-style narrow body design, reducing volume by up to 60% ;
Up and down straight-through heat dissipation, multiple inverters can be installed side by side device, greatly reducing the volume of the electrical cabinet ;



AC310 series high-performance inverter

The AC310 series inverter is a high-performance vector inverter that is a continuation of the AC300 hardware structure design concept by Veichi, it retains the characteristics of the new generation of Veichi products, and breaks through innovation in functional performance. It not only adopts the international leading field-oriented vector control technology, but also enriches the control methods of various forms of load such as voltage-frequency separation EPS power supply on the basis of compatible asynchronous and synchronous motor control. Under the premise of ensuring product high performance and high reliability, rationally layout parts, maintain product book-style narrow body design, pay attention to product ease of use and industry-specific design, and better solve customers' product selection troubles. It is equipped with abundant expansion ports and a variety of expansion accessories to achieve the characteristics of high performance, high reliability, high power density and high applicability.

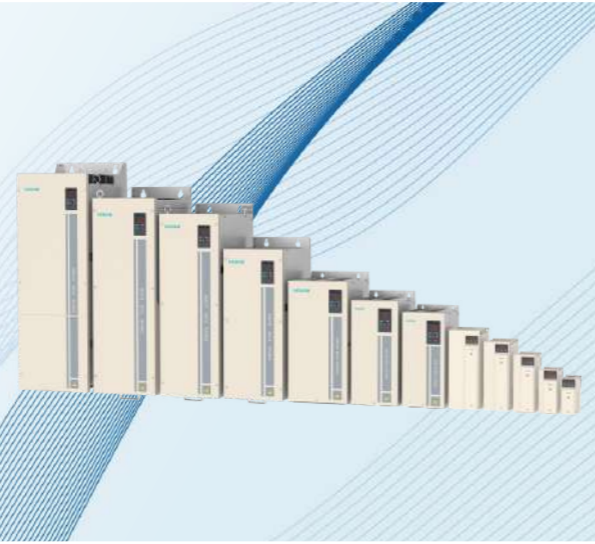

Product features



High-performance vector universal platform, new motor control algorithm	Synchronous and asynchronous drive integration, open loop and closed loop comprehensive	Precise torque excitation decoupling, excellent dynamic response performance
The whole series adopts book-design, maximize the installation space savings	Integrated thermal simulation design to ensure prove the rationality of hardware arrangement	Brand new air duct design, full range DC fan heat dissipation, safe and reliable
AC310 series innovative connection place type, quickly solve electromagnetic interference problems	Software and hardware modular design requirements demand, powerful expansion capability	Comprehensive expansion interface, rich configuration selection of spare parts, covering various applications
Convenient keyboard design, support the new external keyboard	Simpler and more convenient on-site debugging segment, support field firmware upgrade	Three-proof design of the whole machine, PCBA spraying three anti-paint to ensure product stability and reliability

General specification

AC 310 series	
Power level	Single phase 220V 50/60Hz 0.75-220kW
	Three phase 220V 50/60Hz 0.75-220kW
	Three phase 380V 50/60Hz 0.75-1200kW
Input	Allow voltage fluctuation Voltage : 320V~480V Voltage imbalance rate:<3%
	Allow frequency fluctuation Frequency: ±5%
	Distortion rate IEC61800-2
Output	The output voltage 0-Input voltage, deviation is less than 5%
	Output frequency range 0-600Hz
	Overload capacity 150%Rated current 1min 180%Rated current 10s 200%Rated current 0.5s

Performance features

Support multiple types of motors/loads

AC310 series inverters are customer diversity, can drive ordinary three-phase asynchronous motors, variable frequency motors, AC servo motors, permanent magnet synchronous motors, high-speed synchronous motors, spindle motors, synchronous reluctance motors, torque motors, linear motors, etc.

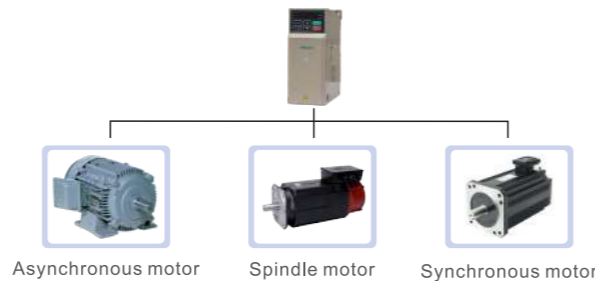

Control mode selection

Control mode	Speed control	Torque control	Position control	Applicable motor
VF mode	●			Asynchronous motor
Voltage frequency separation	●			Torque motor, EPS power supply, series resonance
High performance vector without PG	●	●		Asynchronous, permanent magnet synchronous
High performance vector with PG	●	●	●	Asynchronous, permanent magnet synchronous, synchronous reluctance

Standard machine "special" use, function in one

AC310 continues the innovative mechanism of the 300 series, retains the original product features, and is committed to solving the troubles of customer selection and improving market competitiveness. It has industry expansion functions. It can expand and increase parameters according to the actual use industry, and integrates multiple industry parameters. So as to realize the "special" use of the standard machine and the integration of functions.

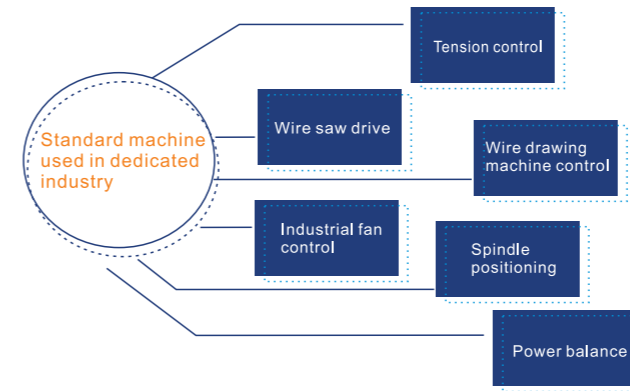

Actively respond to industry4.0

With the continuous reform of intelligent production, centralized control of products becomes more common. AC310 products can support communication with different types of DCS systems and PLC systems, and can support direct communication between various types of touch screens and AC310. MODBUS-RTU communication is standard and compatible options. It is optional for PROFIBUS-DP, CANOPEN, PROFINET communication protocols.

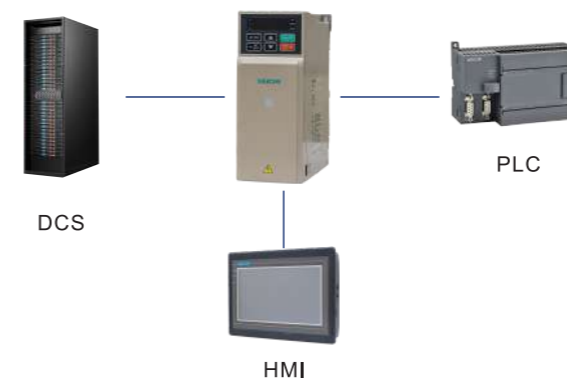

Excellent control performance

Control mode	Speed control range	Starting torque	Applicable motor
High performance vector without PG	1:200	150%	Permanent magnet synchronous motor
High performance vector without PG	1:100	150%	Asynchronous motor
High performance vector with PG	1:1000	200%	Asynchronous, permanent magnet synchronous motor

Closed-loop torque response <10ms, steady speed accuracy 0.02%, speed ripple 0.2%
Open-loop torque response <20ms, stable speed accuracy 0.2% (synchronous), 0.5% (asynchronous)
The highest vector output frequency is 600Hz, and the lowest carrier frequency is 1KHz

Voltage frequency separation, professional drive

The comprehensive and abundant dedicated function algorithms for voltage-frequency separation can effectively drive torque motors and realize steady-state control of EPS power supplies. At the same time, it is widely used in a variety of withstand voltage test equipment in power applications.



Software suppression function

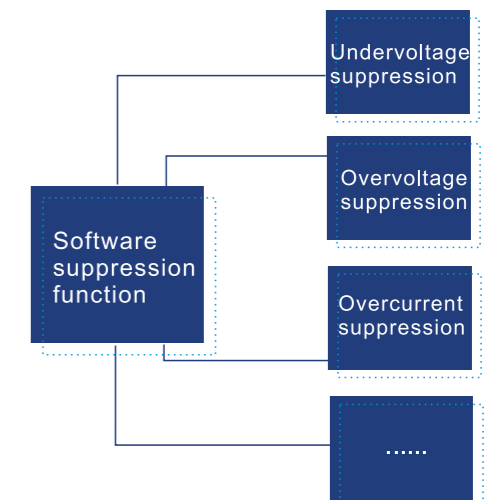

High starting torque characteristics

Low frequency torque is large. In the closed-loop vector mode, 200% rated torque can be output at 0.0Hz, It can run stably with load at ultra-low speed of 0.01Hz. Powerful low-torque output, which can effectively Ensure the stability and smooth start-up.



In torque control mode, the torque output is stable. The linearity deviation is within 3%, which greatly guarantees the stable operation of the equipment.

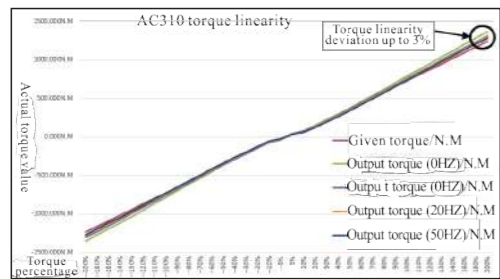

Overexcitation braking function

In the case of partial inertia shutdown, the braking resistor can be used without increasing the braking resistance, and the over-excitation braking function can be used realize fast braking and improve product ease of use. Over-excitation braking function effectively suppresses the DC bus voltage rises during the deceleration process to avoid inverter over-voltage faults, while achieving rapid braking, quickly stop after a power outage.

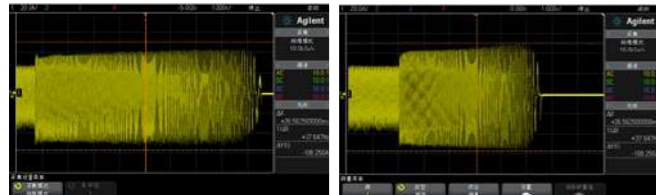

Overexcitation braking function is invalid Overexcitation braking function is effective

Excellent energy saving function

The use of a new generation of energy-saving control technology can realize the efficient operation of induction motors. It can reduce the excitation current according to the load and can also reduce the motor energy loss.

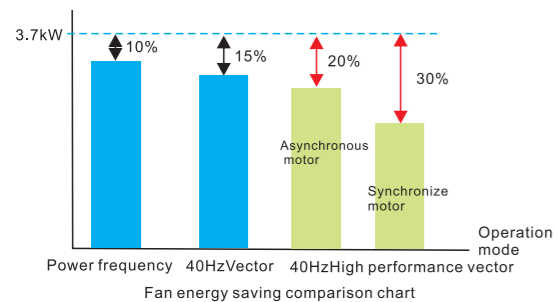

Motor parameter self-learning

Whether in rotating state or the stationary state, the motor parameters can be accurately obtained by self-learning, and the debugging method is convenient and simple to operate, providing higher control accuracy and response speed.

Rotary self-learning

The load must be disconnected for learning, and it is suitable for occasions with high control accuracy requirements.

Static self-learning

The powerful motor self-learning algorithm can obtain the motor parameters when the motor is stationary, and the effect is comparable to rotating self-learning.

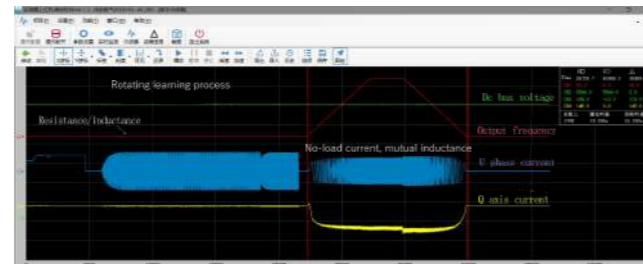

Rotary self-learning

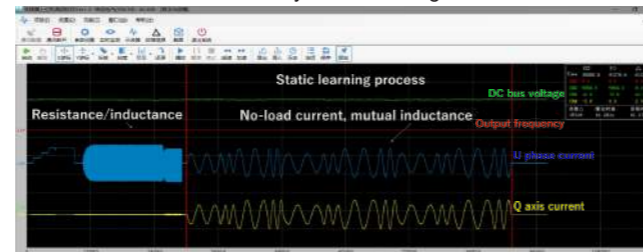

Static self-learning

Stable high-speed field weakening control

The new field weakening control algorithm and the high-bandwidth current vector control algorithm achieve a stable high speed field weakening operation, up to 12 times of field weakening high precision output.

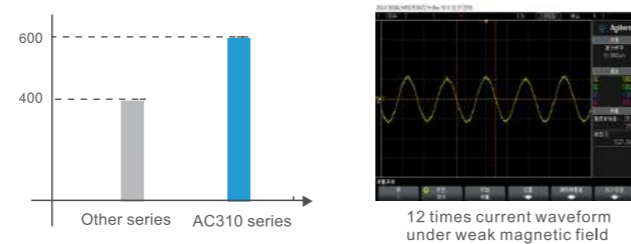

Other series: The maximum output frequency under vector control is 320/400Hz ; AC 310 series: The maximum output frequency under vector control is 600Hz.

Other software functions

Support software online upgrade

Random carrier capability

Powerful PC software

Structural hardware characteristics

Simple internal layout, convenient wiring operation

The whole series adopts narrow-body design and strictly controls the structural size. Various expansion interfaces and wiring terminals are distributed in an orderly manner, and the wiring operation is convenient.

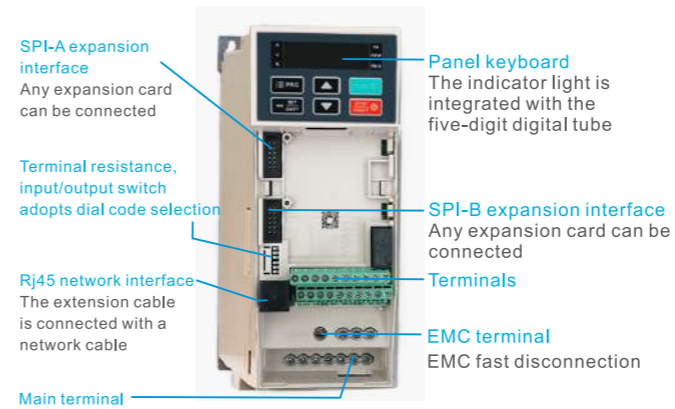

Number of standard terminals

Serial number	Unit circuit	Quantity	Remarks
1	Normal X input	5	Bidirectional input
2	Normal Y output	1	Open collector output
3	Relay output	1	Normally open/normally closed
4	10V power output	1	50mA
	24V power output	1	100mA
5	Voltage/current analog input	2	V/A support free switching
6	Analog output(optional)	1	0-10V output
			0-20mA output
			0-100kHz pulse output
7	Rs485 communication	1	ModBus-RTU
8	Low speed pulse input	1	X5 terminal:0-5kHz input

New book structure

The whole series of AC310 series frequency converters adopts a narrow book design, and the volume is reduced 60%. It is the "book-based machine" in the real inverter.



New structure design

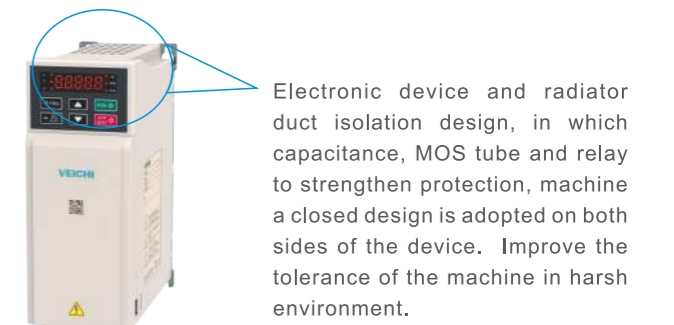

Electronic device and radiator duct isolation design, in which capacitance, MOS tube and relay to strengthen protection, machine a closed design is adopted on both sides of the device. Improve the tolerance of the machine in harsh environment.

Wide tooth surface heat dissipation and high wind speed design. Ensure the full power range inverters can be used without derating of at high temperature.

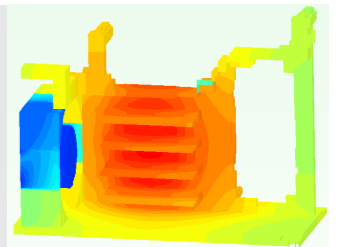

Optimized structure design

Book-style narrow body design, rational use of space, greatly saving customers' main cabinet space and main cabinet cost.

380V 2.2kW example

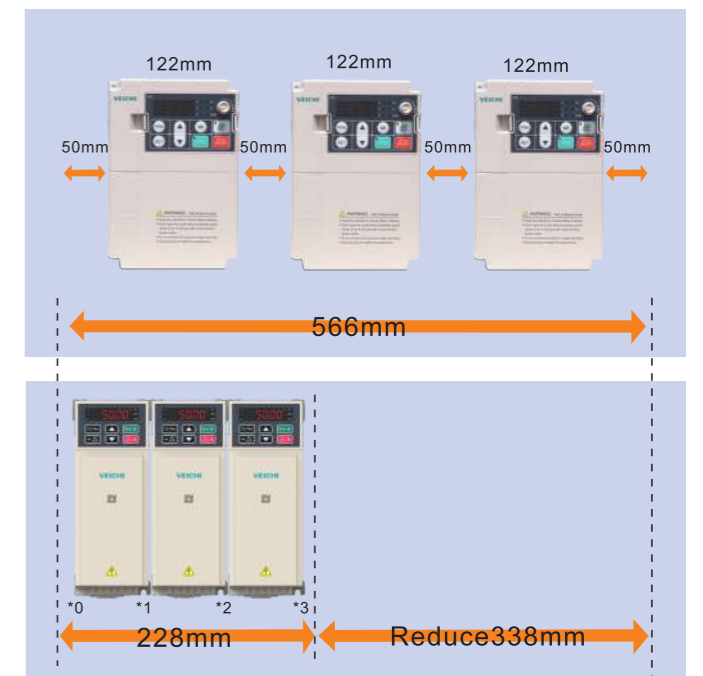

Braking unit and reactor configuration

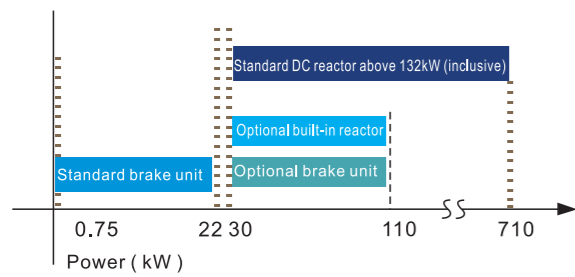

- 0.75~22kW Standard brake unit
- 30~110kW Optional built-in brake unit
- 45kW—110kW Optional built-in DC reactor
- Standard DC reactor for 132kW (inclusive) and above (standard input reactor for 630-710kW)

Port feature dial code selection

Port characteristics are convenient to choose dialing codes. You can quickly select input and output characteristics with a common screwdriver.

Dialing diagram	Tag	Select location	Function Description
RS485 OFF <input type="checkbox"/> ON <input type="checkbox"/>	RS485	485 terminating resistor	RS485 communication access 120 ohm terminal resistance
AO-F OFF <input type="checkbox"/> ON <input type="checkbox"/>	AO-F	AO output frequency	AO interface 0.0~100kHz frequency output
AO-I OFF <input type="checkbox"/> ON <input type="checkbox"/>	AO-I	AO output current	AO interface 0~20mA current output or 4~20mA current output
AO-U OFF <input type="checkbox"/> ON <input type="checkbox"/>	AO-U	AO output voltage	0~10V voltage output
A11 U <input type="checkbox"/> I <input type="checkbox"/>	A11	A11 input-current/voltage	A11 input 0~20mA or 4~20mA or A11 input 0~10V
A12 U <input type="checkbox"/> I <input type="checkbox"/>	A12	A12 input-current/voltage	A12 input 0~20mA or 4~20mA or A12 input 0~10V

Keyboard operation

A newly designed panel keyboard with superior operability. Built-in keyboard and external keyboard support dual line display(control right can be selected through the inverter parameters built-in or external keyboard)

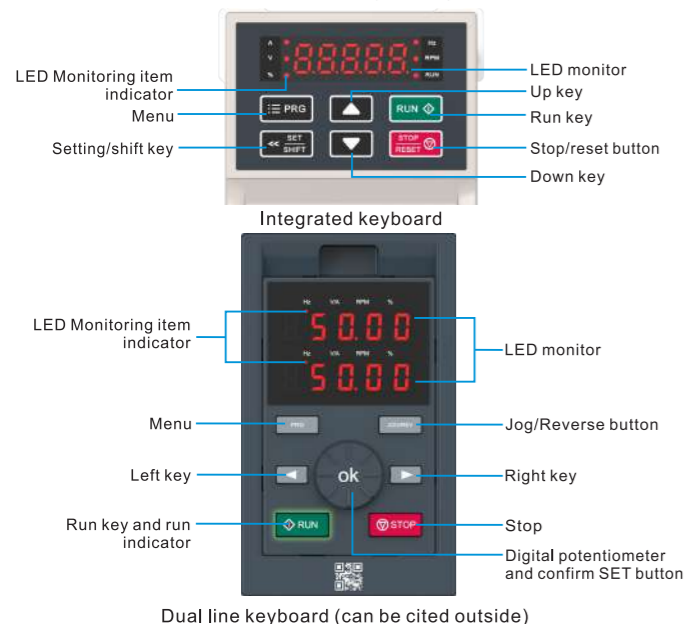

Note: Plastic case below 37KW adopts integrated keyboard, and steel case above 37KW adopts dual line keyboard.

Name	Status	Meaning	
Unit indicator	Hz	Flashing/on	Frequency unit
	A	On	Current unit
	V	Flashing/on	Voltage unit
	RPM	On	Speed unit
	%	Flashing/on	Percentage unit
Status Indicator	RUN	On	The inverter is running forward
	RUN	Flashing	The inverter is running in reverse
	RUN	Turn off	Inverter stop

Fast disassembly and assembly design of the fan

AC310 adopts innovative fan structure design. On the premise of ensuring the stability and efficiency of the fan, it can be replaced and cleaned quickly without the help of external tools.

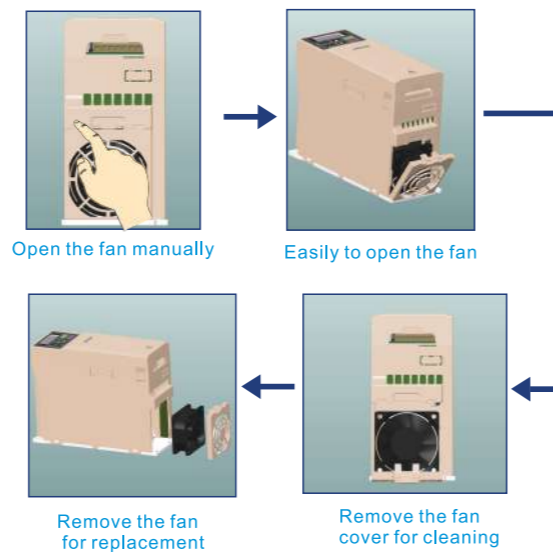

Wide voltage design

The allowable fluctuation range of input voltage is $\pm 15\%$ of rated voltage, it can be protected from voltage fluctuation when using and can meet demanding when in poor city grid.

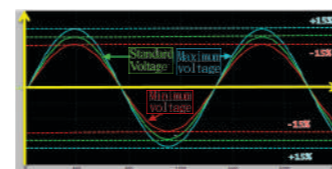

EMC grounding design

Adopt innovative EMC grounding design, grounding can be quickly selected through the terminal or intermittently, effectively solve EMC interference.



European terminal block

Use professional European-style terminals that comply with IEC 60998-2-1; UL 1059; UL 486E specifications while ensuring safety and reliability, it saves connection time: stripping → wire socket number → screw locking. AC310 frequency inverter adopts European-style terminals on the main circuit terminals of low-power machines. Using European style terminals can save at least half of the time compared with before when connecting the cables to the main circuit in the cabinet which greatly improves the customer's assembly efficiency.



Stripping → Socket No. → Crimping Nose → Screw Lock

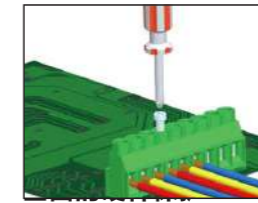

Stripping → Socket No. → Screw Lock

	AC310 model	Wire thread ϕ (mm)	Wire cross-sectional area S (mm ²)	Stripping length L (mm)
Main circuit terminal	0.75kW-2.2kW	0.25-2.5	0.05-5.2	7-8
	4.0kW-5kW	0.5-2.5	0.2-5.2	6-7
	7.5kW-11kW	0.8-4	0.5-13	10-11
Wire stripping diagram				

Protection function

It has output short-circuit to ground protection, internal buffer relay protection, fan drive circuit protection, external 24VDC short circuit protection, motor overload protection and other hardware protection which can comprehensively protect the internal and peripheral equipment of the inverter.

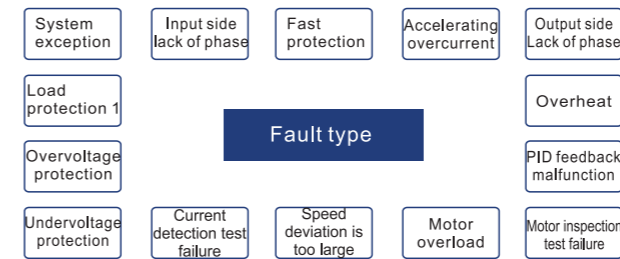

New motor-to-ground short-circuit detection

The inverter will monitor the motor at the start. Once there is a short circuit to the ground, the inverter will give an alarm.

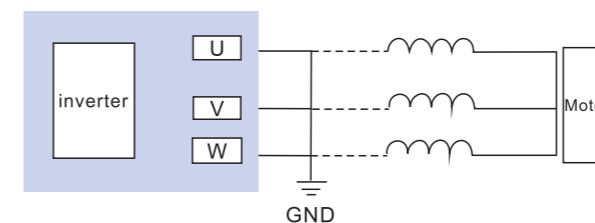

Expandability

Super expansion ability

A variety of extended interfaces to meet customized needs. AC310 control board retains two SPI high-speed channel external extension cards, and the control board automatically recognizes the expansion card also contains the expansion card setting parameter group.

Expansion Card

Expansion card model	Note
IO Expansion Card	Optional, high-speed pulse, relay
Speed tracking card	Optional, multi-type encoder
PG Card	Optional, multi-type encoder
Speed tracking card	Optional
RT resolver card	Optional
GPRS Card	Optional

Communication expansion card

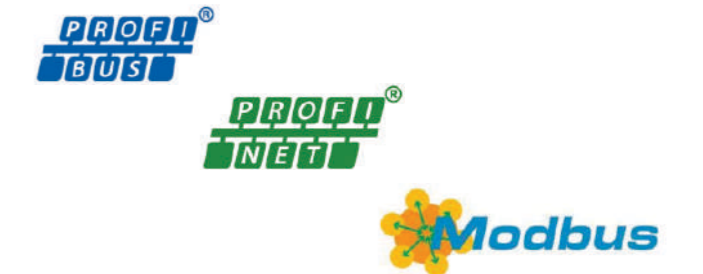

Communication expansion card model	Note
PROFIBUS-DP card	Optional
CANopen card	Optional
PROFINET card	Optional
.....	

IO Expansion Card

Attributes	Terminal	Description
Input IO	ExpandX6/X7/X8/X10	PLC/COM, Co-negative, Co-positive
High-speed pulse input	X10	0-100KHz
Digital output	Extend Y2	DC24V/50mA
Digital output	Expansion relay TA2/TB2/TAC2	3A/240VAC
Relay output	PK+/PK-	Support PT100/PT1000/KTY84, Motor temperature detection
Temperature detection	COM/PLC2	External public
Switch	S7	Input terminal polarity selection

Logic board expansion card

The inverter replaces the PLC to perform simple logic control. It is adopted the program development environment which is widely used in MELSEC programmable controller. The product integrates general and comprehensive function blocks.



Smart IOT of VEICHI

Intelligent terminal, high positioning accuracy, compact and beautiful, easy to install. It adopts GPRS and GSM dual mode communication mode, stable operation and reliable performance. Through the remote monitoring module, online monitoring and remote fault diagnosis are realized, providing customers with a larger range of value-added services.

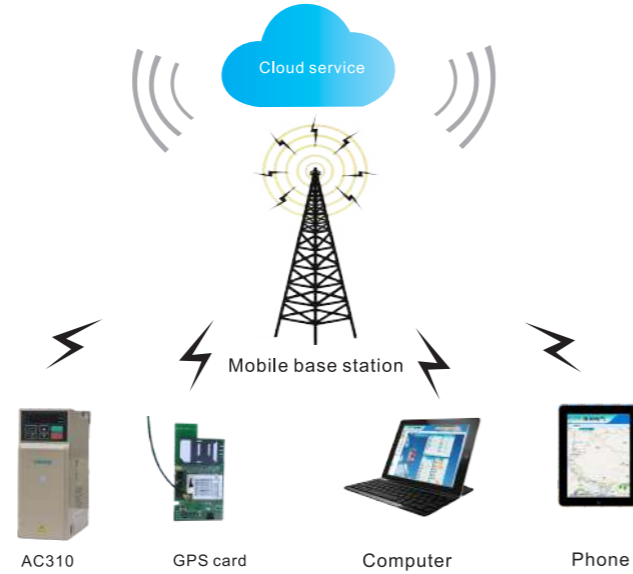

Inverter rated output current

Voltage	220V	380V	Voltage	220V	380V
	Rated output current (A)			Rated output current (A)	
0.75	4	3	160	550	310
1.5	7	4	185	600	340
2.2	10	6	200	660	380
4	16	10	220	720	415
5.5	20	13	250		470
7.5	30	17	280		510
11	42	25	315		600
15	55	32	355		670
18.5	70	38	400		750
22	80	45	450		810
30	110	60	500		860
37	130	75	560		990
45	160	90	630		1200
55	200	110	710		1340
75	260	150	800		1500
90	320	180	900		1620
110	380	210	1000		1980
132	420	250			

Model Description

AC310-T3-037 G/45 P-B (L)

Series name
AC310

Voltage level

Codename	Definition	Codename	Definition
T	Three phase	2	220V
S	Single phase	3	380V
D	DC input	4	440V
		6	660V
		11	1140V

Integrated accessories

- B : Built-in braking unit
- L: Built-in DC reactor
- BI: Built-in braking unit and DC reactor

Inverter type

- G: Heavy load mode
- P: Light load mode

Power level

- 2R2: 2.2kW
- 004: 4kW
-

Installation dimension drawing

Plastic case model

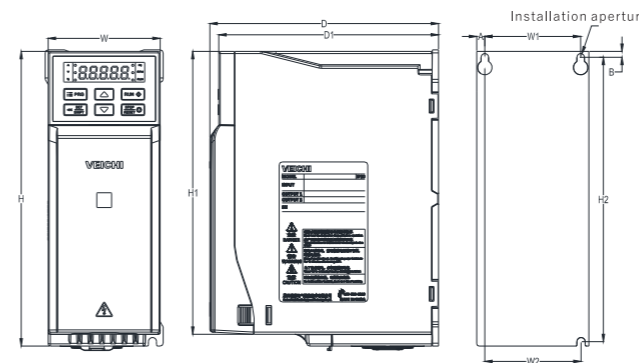

Inverter model	Dimensions (mm)				Installation size (mm)					Installation aperture	
	W	H	H1	D	D1	W1	W2	H2	A		B
AC310-T/S2-R75G-B	76	200	192	155	149	65	65	193	5.5	4	3-M4
AC310-T/S2-1R5G-B											
AC310-T/S2-2R2G-B	100	242	231	155	149	84	86.5	231.5	8	5.5	3-M4
AC310-T/S2-004G-B											
AC310-T/S2-5R5G-B	116	320	307.5	175	169	98	100	307.5	9	6	3-M5
AC310-T3-R75G/1R5P-B											
AC310-T3-1R5G/2R2P-B	76	200	192	155	149	65	65	193	5.5	4	3-M4
AC310-T3-2R2G-B											
AC310-T3-004G/5R5P-B	100	242	231	155	149	84	86.5	231.5	8	5.5	3-M4
AC310-T3-5R5G/7R5P-B											
AC310-T3-7R5G/011P-B	116	320	307.5	175	169	98	100	307.5	9	6	3-M5
AC310-T3-011G/015P-B											

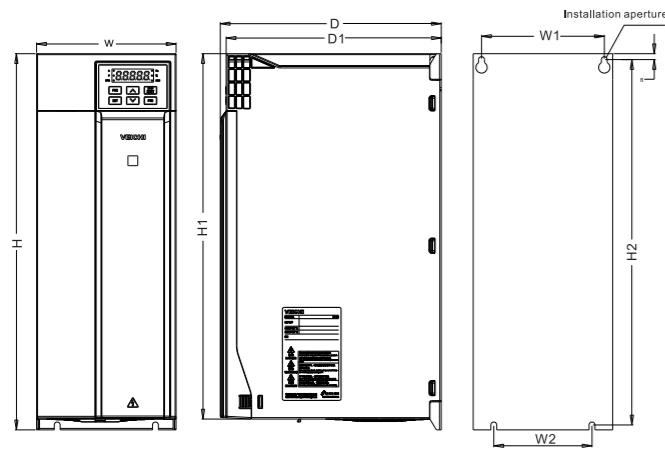

Inverter model	Dimensions (mm)					Installation size (mm)				Installation aperture
	W	H	H1	D	D1	W1	W2	H2	B	
AC310-T/S2-7R5G-B	142	383	372	225	219	125	100	372	6	4-M5
AC310-T/S2-011G-B										
AC310-T/S2-015G										
AC310-T2-018G	172	430	/	225	219	150	150	416.5	7.5	4-M5
AC310-T2-022G										
AC310-T3-015G/018P-B										
AC310-T3-018G/022P-B	142	383	372	225	219	125	100	372	6	4-M5
AC310-T3-022G/030P-B										
AC310-T3-030G/037P										
AC310-T3-037G/045P	172	430	/	225	219	150	150	416.5	7.5	4-M5

Iron case model

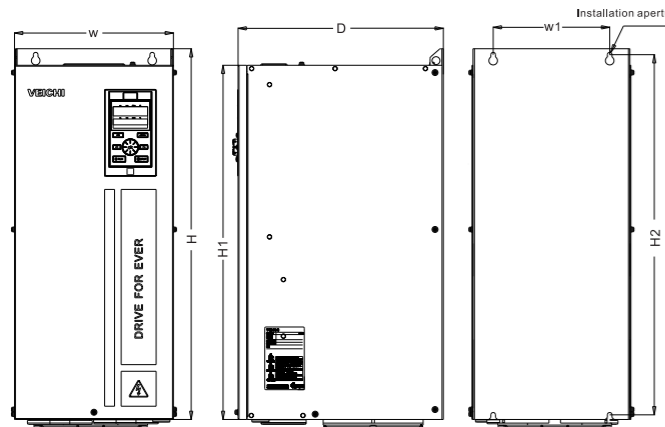

Inverter model	Dimensions (mm)				Installation size (mm)		Installation aperture
	W	H	H1	D	W1	H2	
AC310-T2-030G							
AC310-T2-037G	240	560	535	310	176	544	4-M6
AC310-T2-045G							
AC310-T2-055G	270	638	580	350	195	615	4-M8
AC310-T3-045G/055P							
AC310-T3-055G/075P	240	560	535	310	176	544	4-M6
AC310-T3-075G/090P							
AC310-T3-090G/110P	270	638	580	350	195	615	4-M8
AC310-T3-110G/132P							
AC310-T3-132G/160P-L	350	738	680	405	220	715	4-M8
AC310-T3-160G/185P-L							
AC310-T3-185G/200P-L							
AC310-T3-200G/220P-L	360	940	850	480	200	910	4-M16
AC310-T3-220G/250P-L							
AC310-T3-250G/280P-L	370	1140	1050	545	200	1110	4-M16
AC310-T3-280G/315P-L							

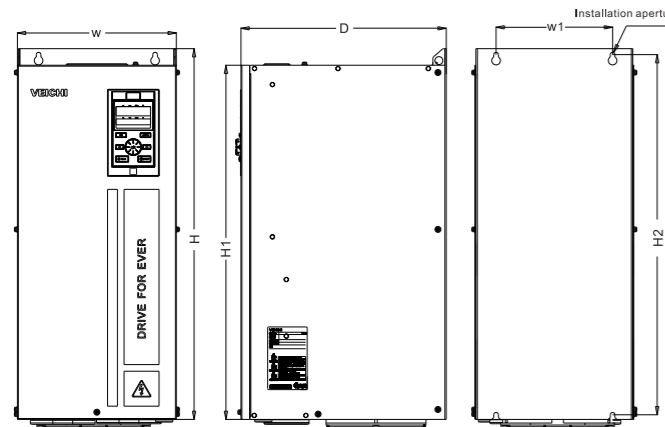

Inverter model	Dimensions (mm)				Installation size (mm)		Installation aperture
	W	H	H1	D	W1	H2	
AC310-T3-315G/355P-L							
AC310-T3-355G/400P-L	400	1250	1140	545	240	1213	4-M16
AC310-T3-400G/450P-L							
AC310-T3-450G/500P-L							
AC310-T3-500G/560P-L	460	1400	1293	545	300	1363	4-M16
AC310-T3-560G/630P-L							

Cabinet model

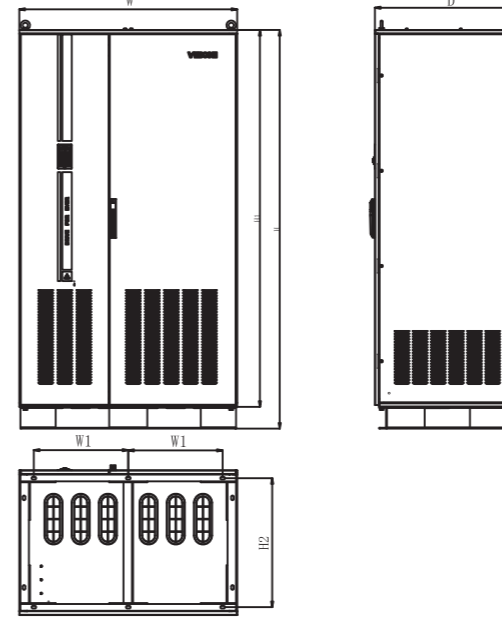

Inverter model	Dimensions(mm)				Installation size(mm)		Installation aperture
	W	H	H1	D	W1	H2	
AC310-T3-630G/710P-L							
AC310-T3-710G/800P-L							
AC310-T3-800G/900P-L	1201	2198	2078	798	520	711	φ14
AC310-T3-900G/1000P-L							
AC310-T3-1000G/1120P-L							

Accessories list

AC300PG01

There are 5V and 12V power PG card, support incremental differential output encoder and open collector output encoder.

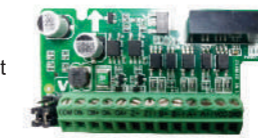

AC300 PN card

Support standard profinet

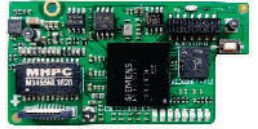

AC300RT1

Supports four different ratios of 0.219, 0.286, 0.5, 0.58, the factory default ratio is 0.5

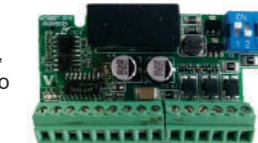

AC300IO1

Four digital inputs(X10 supports 50k pulse input), one digital output one analog input and one relay output. Support temperature detection(PT100, PT1000 and KTY84)



AC300CAN1

CANopen expansion card



KBD10-15

External LED five-digit display and operation keyboard, potentiometer speed control



AC300DP01

Profibus communication expansion card



KBD300-25

Dual line external five-digit display keyboard, silicone buttons, digital potentiometer



AC300-GPRS

Equipment positioning and maintenance, real-time monitoring, data collection



KBD300-L1 LCD keyboard

Have a good LCD interface



Wiring diagram

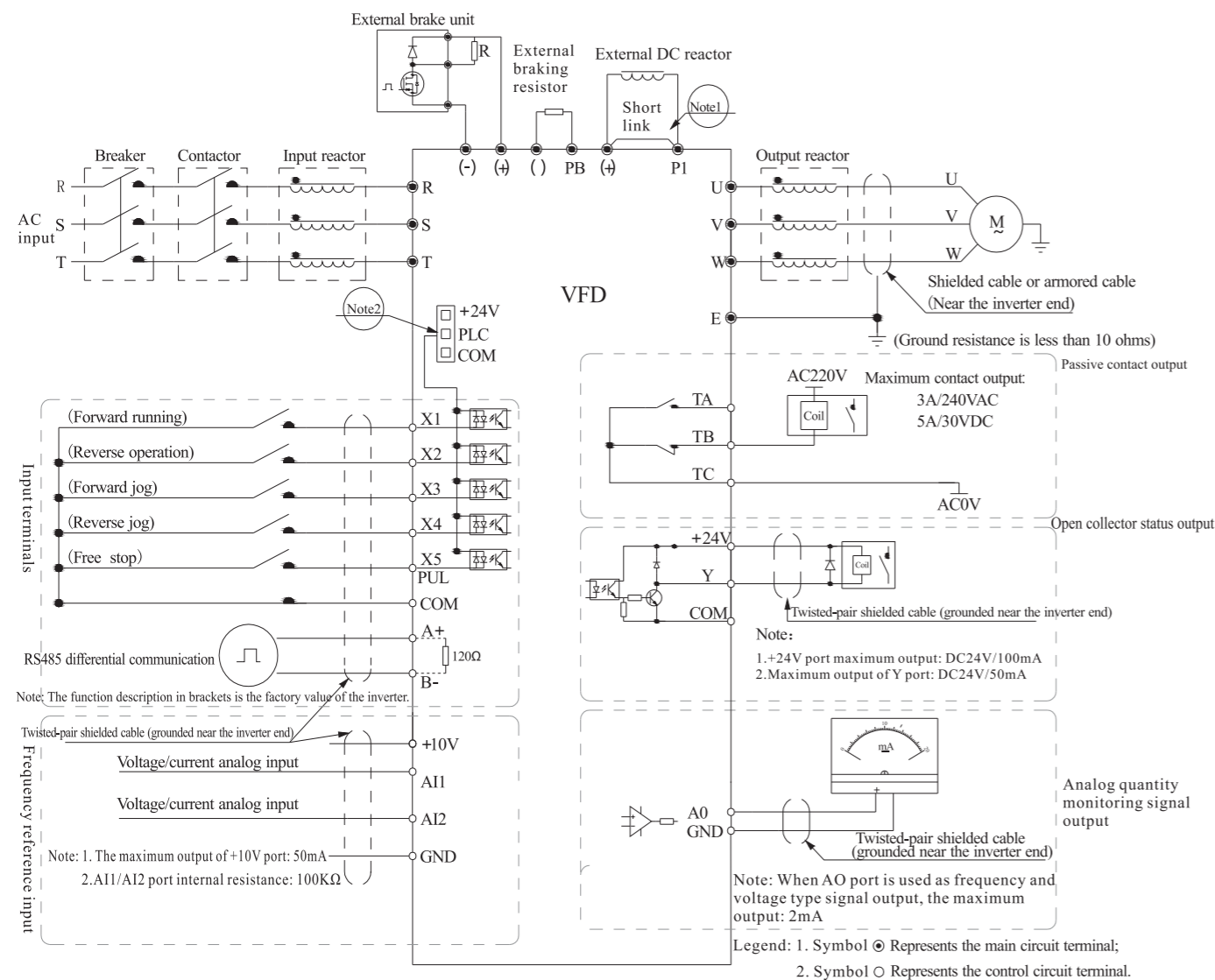

- Note:
1. When installing the DC reactor, be sure to remove P1(+) shorting strip between terminals.
 2. Multi-function input terminals (X1~ X5/PUL) can choose NPN or PNP transistor signal as input, and the bias voltage can choose the inverter internal power supply (+24V terminal), or select the external power supply (PLC terminal). The factory default "+24V" and "PLC" are shorted, and the position of the shorting piece is between RJ45 and the terminal.
 3. The analog monitoring output is dedicated output for indicator meters such as frequency meters, ammeters, and voltmeters, and cannot be used for control operations such as feedback control.
 4. Since there are many types of pulses in actual use, please refer to the detailed description for specific wiring methods.

Application field

